

DMS TILT

DMS-03 PTS050

DMS
DMS Technologie GmbH

TECHNICAL DATA

Weight (incl. bolts)	[kg]	> 105
Swivel angle	[°]	180
recomm. closing pressure	[bar]	35-50
Opening pressure	[bar]	min. 35 max. 240
Tilting pressure	[bar]	210
Torque at 207 bar	[Nm]	2600
Holding torque at 225 bar	[Nm]	9350
max. hook load	[kg]	2000
comp. to Symlock		SY-03

TECHNICAL DRAWING

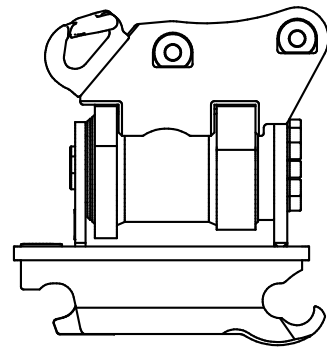

For more information and a 3D preview, visit www.dms-tec.de/en

