

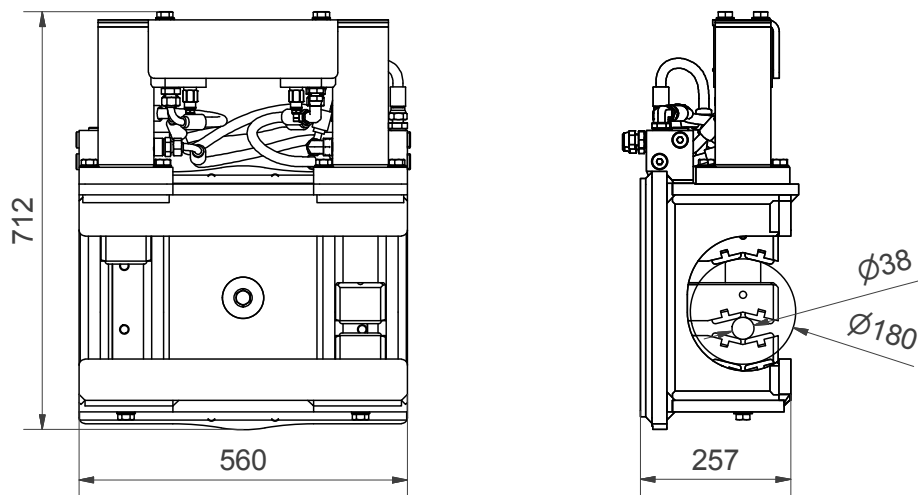

DMS Technologie GmbH

Gewicht [kg]:	230
Tragkraft [kg]:	500
Betriebsdruck max. [bar]:	160
Klemmkraft max. [kn]:	100



# MP38-240

Manipulator

[www.dms-tec.de](http://www.dms-tec.de)

